

SMARTSTRINGS™

4 Wheel Toe Alignment System



SmartStrings 4 wheel toe alignment kit. We now have what we believe to be the best and most universal way to quickly perform accurate four-wheel alignments on virtually any car anywhere.

Why SmartStrings? The number one design premise was to allow all four wheels to be aligned with one simple, accurate, portable and affordable tool. Just so you know, some of the fastest cars in the world - including Indy style cars, 200 mph road racing cars and NASCARs are aligned with strings (or wire in some cases).

As with our SmartCamber gauge, SmartStrings were designed to be used on as wide a variety of cars as possible; it's telescoping design in all three planes assures that. The attaching or hooking features on the Attaching Arms have also been carefully thought out to be as versatile as possible.

Unlike nearly all other toe measuring gauges on the market today, our SmartStrings allow you to simultaneously align and "square" the car, that is, insure that the rear axle is running true and parallel to the front axle. Also, since our strings attach to the car, they move with the car so when adjustments are made, the vehicle can be rolled to settle the settings without the worry or bother of the gauge having to be

recalibrated. Since you can adjust all four wheels relative to one another, you can set the car up however you like, or however track conditions require. Properly installed, the parallel strings form a perfect parallelogram around the car's own centerline!

Combined with our **SmartCamber** camber/caster tool, you can perform a full four-wheel alignment and know for yourself that the numbers are correct and to your individual needs or liking.

Part No. 011410
\$407.99

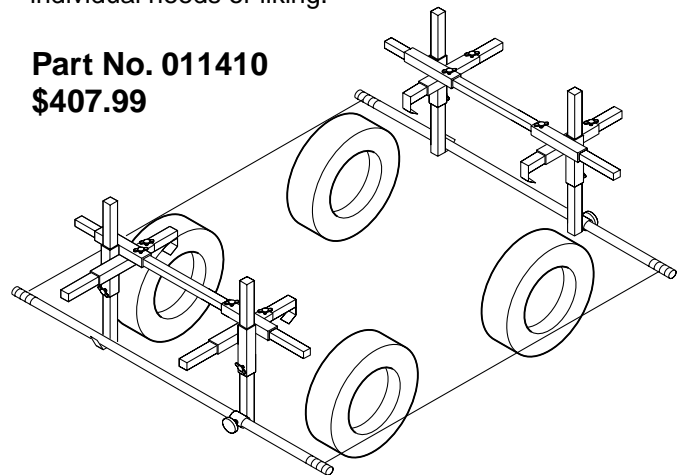

SMARTCAMBER



Our SmartCamber tool digitally measures camber and caster quickly, easily, and repeatable. With the push of a button it automatically compensates for non-level floors so it can be used at home, at the track...even on a trailer with complete confidence. Plus, the module is removable and can be used for measuring any angles, including drive shafts, wing and suspension angles, so it is really two tools in one. Most effectively used with the optional Hands-Free adapter because it allows the tool to be attached to the wheel while suspension adjustments are made; fast, accurate and super easy.

- SmartCamber**
(5" to 22" wheels) 011351 \$214.95
- Hands-Free adapter 011361 \$44.95
- Complete with Hands-Free
adapter 011371 \$259.90
- Carrying case 011281 \$101.70
- 3.75 inch Standoff 011142 \$5.50 ea

SmartCamber with Hands-Free adapter



SmartCamber Carrying Case

Hand made lacquered birch plywood box with specially designed anchor screws to hold the tool in place

- 011281 \$101.70



**Longacre Computer Scales
The Matrix**

Simple to use. Large displays. Pick any % you want - no limits then push one button its just that simple. No thick instruction manual needed here.

- Heavy duty Yellow cables. billet connectors. luggage grade carrying case
- Memory holds 8 complete setups with quick and easy recall
- Internal battery and charger included (can use 9 volt alkaline for emergency)
- Smooth top 15" low profile pads with handles and recessed connectors
- 1/10% accuracy and 1500 lbs. per pad capacity

011650 \$1,270.00



**Longacre Computer Scales
AccuSet**

New low cost scale. Simple to use - just push 2 buttons to get everything you need.

- Push one button for all 4 wheel weights
- Push a second button for all partial %
- See all your partial weights - at the same time or all 4 wheels weights plus total
- Heavy duty Red cables and silver AN connectors
- Included molded carrying case for electronics cables, battery and charger
- A 9 volt alkaline battery can be used for emergency power
- 15" Low profile pads with convenient carrying handles

011651 \$1,098.00

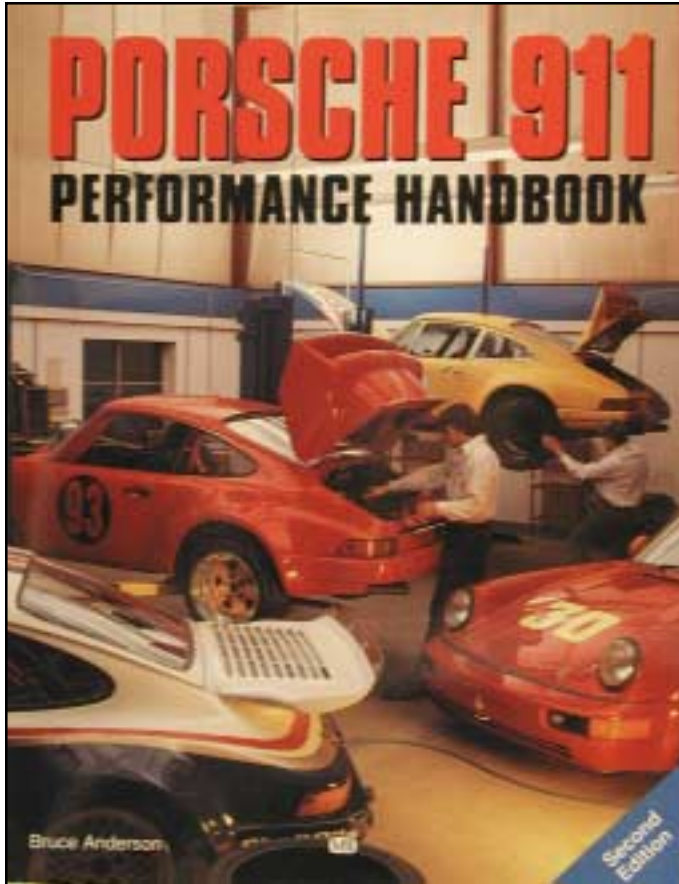

Porsche Performance Handbook
272 pages of pure Porsche!

Packed with information from Porsche history to performance modifications, tuning, maintenance, suspension, tires, and more. This Handbook has been expanded and updated with the most current information available.

070911 \$24.95

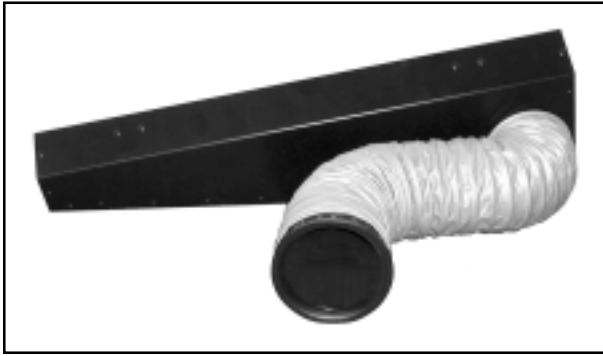

911 Driver's Air Ventilation Kit

Replaces the factory heater/ventilation system under the cowl and blows generous amounts of air to the driver. The air comes out through the clock hole. A bolt-in installation. 911 '69 to '89

041100 \$231.45



Optional Adjustable Vent for Air Ventilation Kit

041150 \$27.08



**Smart Racing Products/
Jerry Woods Enterprises T-Shirt**

Blue with white graphics or white with blue graphics. Sizes Medium, Large, X-Large, or XX-Large.

02104X \$12.50



Camera Mount
051100 \$109.95



911 Throttle Stop Kit
This throttle stop mounts to the pedal board like in the early 911's. We made this for the Toyo 911 Cup car (911cup.com)
041101 \$28.95



Ride Height Wrench-911/930
Fits the factory adjustable spring plate fasteners for '89 and earlier cars. 24mm and 36mm combination wrench.
012011 \$57.95



Front Mono Ball Hook Wrench
The SmartRacing front Camberball kit has a castle lock nut on top. This is the proper tool for tightening the lock nut. The Camberball kit - Part No. 452101
012030 \$27.27



ERP 935 Toe Adj Wrenches
These wrenches are needed to properly adjust the ERP 935 rear spring plate kits. Short and thin, they fit the adjusting nuts perfectly. All 3 sizes needed per car.
1-1/16" 012040 \$41.84
1-1/4" 012045 \$32.10
28mm 012055 \$27.50



Fox Shox Coil Over Ride Height Wrench
012080 \$32.50



Tie Rod Wrench-911/914/930
When removing the tie rod assembly (from the rack) on a 911 or 914 and replacing it with the 930 style, you need two different kinds of wrenches. Not true. Smart Racing has the two tools in one for the non-turbo tie rods and the other for 930 tie rods. The right tool for the job.
012021 \$43.90



Coil Over Ride Height Wrench
This hook wrench properly fits the coil-over nuts in our front and rear suspension kits.
012070 \$40.00



Racetech Head Restraint
032103 \$114.95



M&R Axle Strap
2" wide 33" long single ply sleeved with D rings. 5000# NBR
034121 \$9.85



M&R Ratchet Wheel Strap
2" wide 10' long ratchet handle wheel strap. Direct snap hook fixed end and twist snap hook long end. 5000# NBR
034101 \$30.25

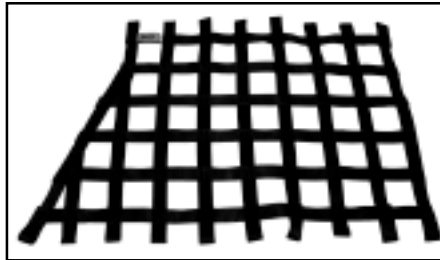

M&R Window net
22" TW x 27" BW x 18" H, top and bottom loops, 1" nylon, 2" box, and SFI 27.1
032101 \$26.95

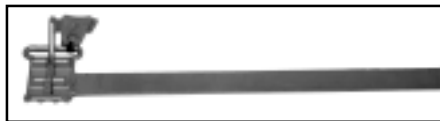

M&R Window Net Rod Lever Latch Flat Bar
Steel top bar, 3/16" x 1" x 28" bar, seat belt buckle, and mounting brackets.
032123 \$37.95



M&R Window Net Rod Lever Latch Round Rod
Steel top rod, 3/8" diameter by 28" long, seat belt buckle, and mounting brackets.
032121 \$35.95

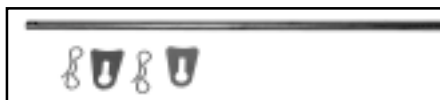

M&R Window Net Rod Round
Steel bottom rod, 3/8" diameter by 28" long, mounting brackets, and cotter pins.
032122 \$50.75

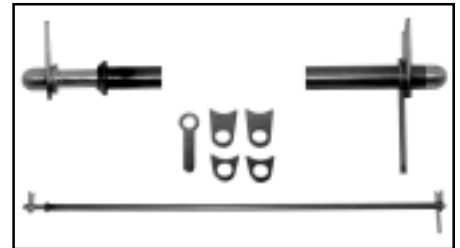

Window Net Mounting Kit 36"
Excellent system for your Porsche. Slide spring-loaded bar back to remove or latch window net in place. Use one at top and one at the bottom for easy removal of window net. Rod can be shortened. See installation instruction sheet 032125.
032125 \$84.75 each
Two kits required to do as shown in photo.



M&R Seat Belt/Shoulder Harness
Grand National "Lo Pro" Lever latch 6 point kit. Shoulder harness 3" wrap around 48" long dual belt. Lap belt 3" pull down adjustable snap-in. Sub belt 1-3/4" dual leg adjustable snap-in. SFI 16.1
031101 \$71.95

**Installation Instructions
and User Manuals
Available on the WEB**



ProtectAll Polish and Wax

For the do-it-yourselfer, show car enthusiast, detail business or dealership, advanced formula Protect All beautifies all surfaces with only one product. The quick and easy spray application takes less time and effort than you ever thought possible.

- Cleans • Polishes • Waxes
- Treats • Protects

Paint, fiberglass, clear coat, gelcoat, chrome, aluminum, stainless steel, plastic, glass, plexiglas, mirrors, vinyl, rubber, finished leather and more!

Quick and Easy -

Just spray on and wipe dry.

No Detailing -

Dries clear, no brush or Q-tip needed.

Carnauba Wax -

Durable protection, showroom shine.

Ultra-Violet Blocker -

Protect against sun damage.

Non-Abrasive -

Safe for clear coats and custom paint.

Economical -

Replace multiple cleaners/polishes.

Non-Oily -

Dry natural appearance on vinyl, rubber and plastic.

Anti-Static -

Slick, non-static finish cleans easier..

061100 7.00



Pro 360 SmartTool Pro 3600

Digital SmartLevel Modules

The PRO 3600 Digital Protractor is a tool that provides you with an immediate digital indication of level, plumb and all the angles in between. With a resolution of .01 from 0-10 and 0.10 degree from 10 to 90. Accurate throughout the protractor's 360 degree range. A RS-232 serial port connector allows downloading of data to a computer or peripheral.

Pro 3600 Protractor 011031 \$349.00

The PRO 360 Digital Protractor is a tool that provides you with an immediate digital indication of level, plumb and all the angles in between. Machined aluminum frame provides unsurpassed accuracy throughout the protractor's 360 degree range.

Pro 360 Protractor .. 011021 \$238.57

The SmartTool Digital Protractor is a tool that provides you with an immediate digital indication of level, plumb and all the angles in between.

SmartTool..... 011041 \$101.95

The SmartTool Modial w/90° Offset

011051 \$128.33



Plexus Plastic Cleaner Protectant and Polish

The most effective product available for cleaning, protecting, and polishing all kinds of plastic. Plexus is easier to use than ordinary cleaners. Its convenient aerosol applicator prevents dripping, leaking, evaporating, and coagulating at the tip of

the nozzle (as is common with pumps and squeeze bottles). To use Plexus, simply spray and wipe - no buffing, no mess, and no waste. Plexus is easy to use and contains no CFCs .

Plexus protects plastic more effectively than ordinary cleaners. Because Plexus seals the pores in plastic surfaces with a micro-thin layer of shiny, protective wax, plastic becomes resistant to debris, oil, scratches, and eventual yellowing. And its anti-static properties repel dust and lint.

061200 13 oz can \$9.95



Longacre High Density Roll Bar Padding

- Pre-tape adhesive
- Will not drip/melt in fire
- Provides maximum in safety and flame retardation
- Fits bars for 1-1/2" to 1-3/4", 36" length
- Used by many Nextel Cup and BNG teams

032130 Black Padding \$14.95



Longacre 14 in. Mirror

2" - 5-1/2" range bolt-on brackets

032201 Mounts on 1-3/4" bar ... \$59.95

032202 Mounts on 1-1/2" bar \$59.95

1/2" - 2-1/2" range bolt-on brackets

032203 Mounts on 1-3/4" bar ... \$59.95

032204 Mounts on 1-1/2" bar \$59.95

032205 Replacement Mirror

14 inch \$26.50



Longacre Brake Bleeder Bottles

- Magnet holds bottles while you bleed your brakes - no more spilled fluid
- Hoses connects to bleeder valves, cap for hoses prevents leakage during storage
- No leak, no spill

015050 (2 bottles) \$29.95

O Accessories

SMARTRACING PRODUCTS

011445	Longacre toe-in plates	62.80	015031	Bead Form Tool II with box	419.00
011480	ART Laser Toe Plates	399.98	021047	Sweatshirt Blue w/White, X-Large	24.50
011611	Longacre Tire Pyrometer Probe, adjustable	62.95	032124	Eye Bolts	8.00
011621	Longacre tire gauge, 0-30 by 1/2 lb., white face.	24.95	050001	Intercomp On Board Lap Timer with Case, Display, Receiver, and Beacon.	299.00
012090	Valve Adjustment Feeler Gauge	5.00	065100	Dow 730, 3 oz.	98.35
012091	Feeler Gauge Replacement Blades, 5 pack..	5.95	065110	Dow 111 Silicone Grease, 5.3 oz.	14.95
015011	Bead Form Jr. with box	419.00			
015021	Bead Form Tool I with Box	419.00			